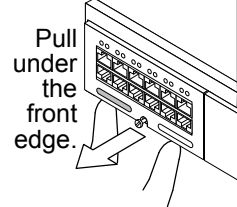
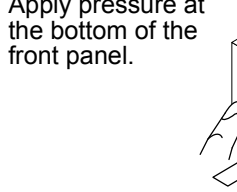
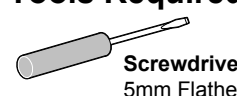
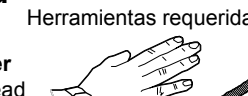

 <p>Shut Down, Power OFF The IP Office system must be shut down and then power to the IP Office system must be OFF during installation of all cards.</p>	<p>Le système IP Office doit être hors tension lors de l'installation de toutes les cartes. Während der Installation der Karte unbedingt jegliche Stromzufuhr ausschalten. Spegnere il sistema "IP Office" prima di installare le schede. La fuente de alimentación al sistema "IP Office" debe estar apagada durante la instalación de todas las tarjetas. A alimentação do sistema "IP Office" deve estar desligada durante a instalação de qualquer placa. Tijdens de installatie van de kaarten dient de voeding naar het "IP Office"-systeem uitgeschakeld te zijn.</p>
 <p>Anti-Static precautions must be observed at all times.</p>	<p>Les précautions anti-statique doivent être respectées à tout moment. Unbedingt immer Antistatik-Vorsichtsmaßnahmen treffen. Proteggersi sempre dalle scariche elettrostatiche. Se deben seguir las precauciones contra la estática en todo momento. É preciso observar sempre os cuidados de proteção antiestática. Neem te allen tijde de antistatische voorschriften voor personen in acht.</p>
 <p>Pull under the front edge.</p>	<p>Tirez le bord avant. An der unteren Kante herausziehen Tirare sotto al bordo anteriore. Tire de abajo del borde delantero. Puxe pela borda inferior. Voorzichtig aan de voorkant uittrekken.</p>
 <p>Apply pressure at the bottom of the front panel.</p>	<p>Appuyez sur le bas du panneau avant. An der Vorderseite unten drücken. Aplicar la presión en el fondo del panel delantero. Aplique presión en el fondo del panel delantero. Exerça pressão na parte inferior do painel frontal. Druk voorzichtig op de onderkant van het voorpaneel.</p>
<p>Tools Required</p>  <p>Screwdriver 5mm Flathead</p>  <p>Anti-Static Strap Bracelet anti-statique/ Antistatisches Armband/ Fascetta antistatica/ Tira antiestática/ Pulseira antiestática/ Antistatisch riempje.</p>	<p>Outils nécessaires./Benötigtes Zubehör und Werkzeug/Utensili richiesti./Herramientas requeridas/Ferramentas necessárias/Benodigd gereedschap.</p>
<p>More Information</p> <p>- IP Office Knowledge Base http://marketingtools.avaya.com/knowledgebase - Avaya Support http://support.avaya.com/</p>	<p>For more information/Pour plus d'informations, voir/Weitere Informationen/Per ulteriori informazioni/Para más información/Mais informações/Voor meer informatie.</p>

A IP 500 Base Card Installation

1  Anti-Static precautions must be observed at all times.

2 Optional: See (B)

3  Shut Down, Power OFF

4 Any unused slot.

5

6

7 Apply pressure at the bottom of the front panel.

8

Analog Phone Cards: Maximum 4
- IPO 500 EXTN CARD PHONE 8 (700417231)
- IPO 500 EXTN CARD PHONE 2 (700431778)

DS Digital Station Cards: Maximum 3
- IPO 500 EXTN CARD DGTL STA 8 (700417330)
- IPO IP500 EXTN CARD DGTL STA 8 TAA (700501512)

TCM Digital Station Cards: Maximum 4
- IP IP500 EXTN CARD TCM-8 DGTL STA 8 (700500758)

ETR Phone Cards: Maximum 3 - Basic Edition Only
- IPO IP500 V2 ETR CARD (700476039)

Voice Compression Cards: Maximum 2
- IPO 500 MC VCM 32 (700417289)
- IPO IP500 VCM 32 TAA (700501518)
- IPO 500 MC VCM 64 (700417397)
- IPO IP500 MC VCM 32 V2 (700504031)
- IPO IP500 VCM 32 TAA V2 (700504033)
- IPO IP500 MC VCM 64 V2 (700505032)

Combination Cards: Maximum 2 - IP500 V2 Only
- IPO IP500 COMBINATION CARD ATM (700476013)
- IPO IP500 COMBINATION CARD ATM V2 (700504556)
- IPO IP500 COMB CARD ATM TAA (700501513)
- IPO IP500 COMBINATION CARD BRI (700476021)

Application Card: Maximum 1 - IP500 V2 Only
- IPO UC MODULE (700501442)
- IPO UC MODULE V2 (700507449)

Expansion Card: Maximum 1
- IPO 500 EXP CARD 4 PORT (700472889)
Slot 4 only.
Slot 4 seulement.
Slot 4 nur.
Slot 4.
4 slot solo.
Slot apenas 4.
Slot 4.

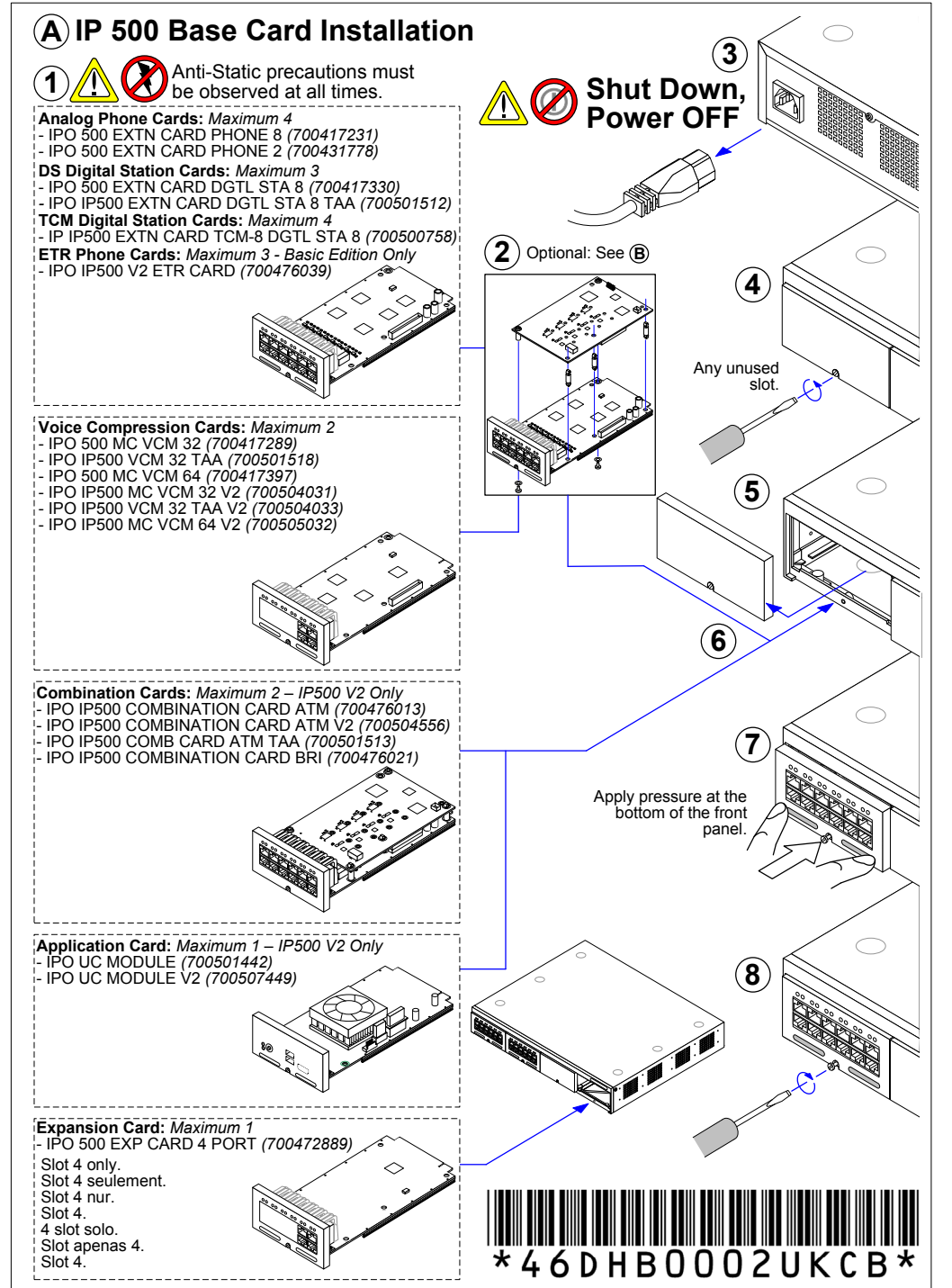



46DHB0002UKCB

B IP 500 Trunk Daughter Card Installation

1 Anti-Static precautions must be observed at all times.

2 **Shut Down, Power OFF**

- IPO 500 TRNK ANLG 4 UNI (700417405)
- IPO IP500 TRUNK ANLG V2 (700503164) (IP500 V2 only)
- IPO 500 TRNK BRI 4 UNI (700417413)
- IPO IP500 TRNK BRI 4 UNI TAA (700501515)
- IPO 500 TRNK BRI 8 UNI (700417421)
- IPO 500 TRNK PRI 1 UNI (700417439)
- IPO IP500 TRNK PRI UNVRSL SNGL TAA (700501514)
- IPO 500 TRNK PRI 2 UNI (700417462)
- IPO IP500 TRNK PRI UNVRSL DUAL TAA (700501517)
- IPOIPO IP500 Trunk CARD T1(J) PRI DUAL JAPAN (700509377)

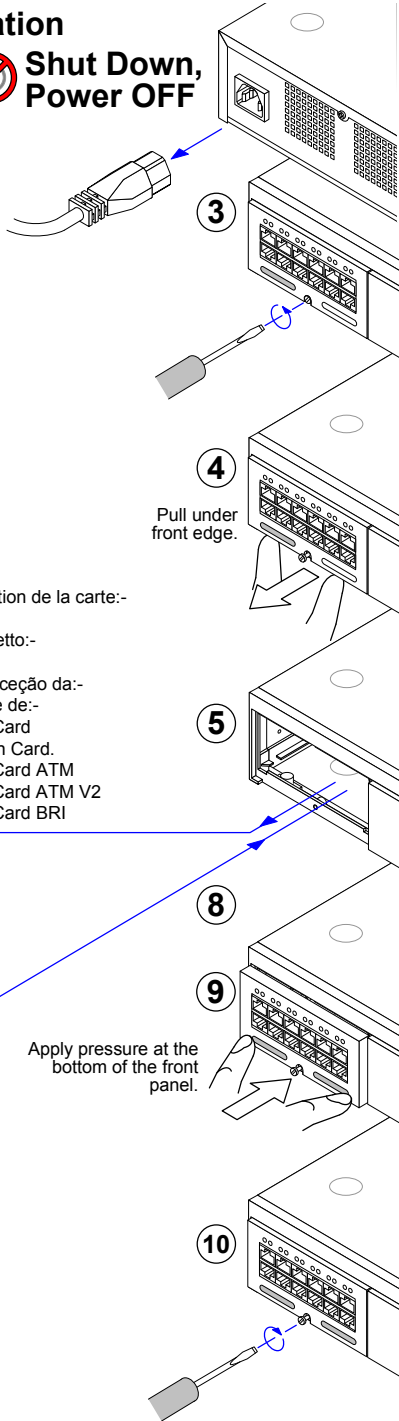
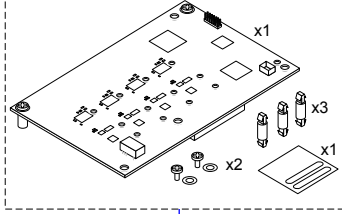

Any base card except:-
 Toute carte de base, à l'exception de la carte:-
 Jede Basiskarte außer:-
 Qualsiasi scheda di base, eccetto:-
 Toda tarjeta base, excepto la:-
 Qualquer placa básica com exceção da:-
 Voor alle basiskaarten behalve de:-

- IPO 500 Legacy Carrier Card
- IPO 500 4 Port Expansion Card
- IPO IP500 Combination Card ATM
- IPO IP500 Combination Card ATM V2
- IPO IP500 Combination Card BRI

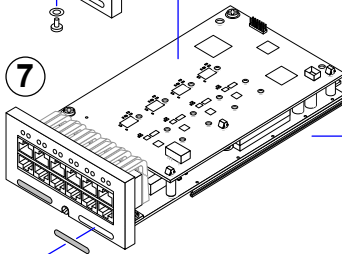
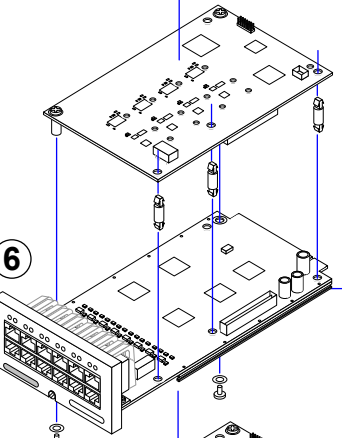

C IP 500 Legacy Carrier Card Installation
 (IP Office Release 4.0 to 9.0 only)

1 Anti-Static precautions must be observed at all times.

4 **Shut Down, Power OFF**

IPO 500 LEGACY CARD CARRIER (700417215) (Maximum 2)

IPO VCM 4 (700358854)
 IPO VCM 8 (700359862)
 IPO VCM 16 (700359870)
 IPO VCM 24 (700359888)
 IPO VCM 30 (700293939)

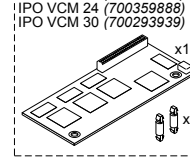
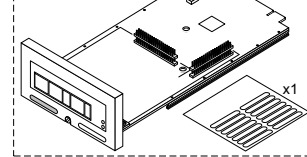

Trunk	Part Number
IPO BRI 8U	(700262017)
IPO PRI 24T1	(700185200)
IPO PRI 48T1	(700185218)
IPO PRI 30E(1.4)	(700272461)
IPO PRI 60E(1.4)	(700272479)
IPO PRI 60E1	(700185184)
IPO PRI 30E1R2	(700241631)
IPO PRI 60E1R2	(700241649)
IPO ATM 4U (US only)	(700359938)

Remove tabs to match trunk card ports.
 Retirez les languettes en fonction des ports de la carte de ligne de réseau.

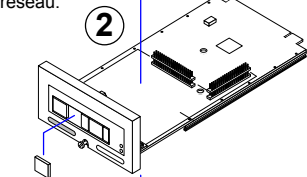

Abdeckungen für die jeweiligen Leitungskarten-Ports entfernen.
 Rimuovere le linguette per consentire l'allineamento con le porte della scheda trunk.
 Quite las piezas para hacer coincidir los puertos de la tarjeta de Enlace.
 Remova as proteções correspondentes às portas da placa de tronco.
 Verwijder de lipjes zodat zij overeenkomen met de poorten van de transmissielijinka art.

